

in access



<sup>2</sup> Because it's **conviction**

design: Bejot



AC 103

- Szyk i elegancja
- Unikalna forma
  
- Schick und elegant
- Einzigartige Form
  
- Stylish and elegant
- Unique shape

AC 102



AC 102 VMS



ergonomic chair



eco friendly  
product



vms

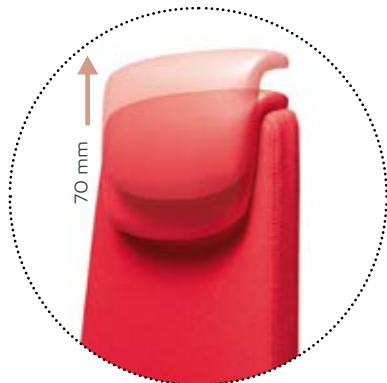

- Regulacja zagłówka.
- Einstellung Kopfstütze.
- Headrest adjustment.

- Dostępne połączenia skóry z tkaniną new blazer.
- Erhältliche Leder - New Blazer Kombinationen.
- The combination of leather and the new blazer fabric is available.

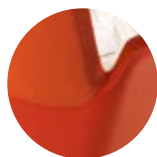

S100+CUZ39

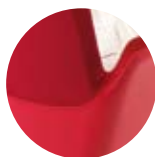

S154+CUZ63

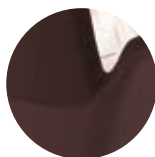

B5458+CUZ67

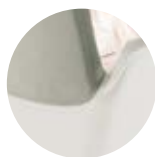

Swhite+CUZ28

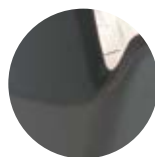

antracyt+CUZ30



Sblack+CUZ30







Fotel AC 210 z mechanizmem samopowrotnym, bez regulacji wysokości siedziska z regulowanym pięciostopniowym zakresem odchylenia oparcia - mechanizm samoważący SELF.

Konferenzstuhl AC 210 mit Ruckholmechanik, ohne Höhenverstellung, mit verstellbarer Rückenlehne mit Arretierung in 4 Positionen.

AC 210 chair with self-reverse mechanism without seat height adjustment, with reclining backrest with lock in 4 positions.



AC 210



AC 216







ACW 720



AC 290

\* model przeznaczony do stref relaksu  
model designed for rest zones



AC 220



AC 225



1  
Regulacja odchylenia kąta oparcia i siedziska.  
- Einstellung des Winkels der Rückenlehne und der Sitzfläche.  
- Synchronus adjustment of the tilt angle of the seat and backrest.



2  
Regulacja siły odchylenia oparcia.  
- Federkrafteinstellung.  
- Tilt force adjustment.



3  
Regulacja głębokości siedziska.  
- Sitztiefenverstellung.  
- Seat depth adjustment (slider).



4  
Regulacja pochylecia siedziska w pozycji do pracy.  
- Lordosenstütze - option.  
- Back lumbar support adjustment - option.



5  
Regulacja wysokości siedziska.  
- Höhenverstellung.  
- Height adjustment.



Regulacja podparcia lędźwiowego - opcja.  
- Lordosenstütze - option.  
- Back lumbar support adjustment - option.



STANDARD  
Mechanizm G

STANDARD  
Mechanismus G

STANDARD  
Mechanism G

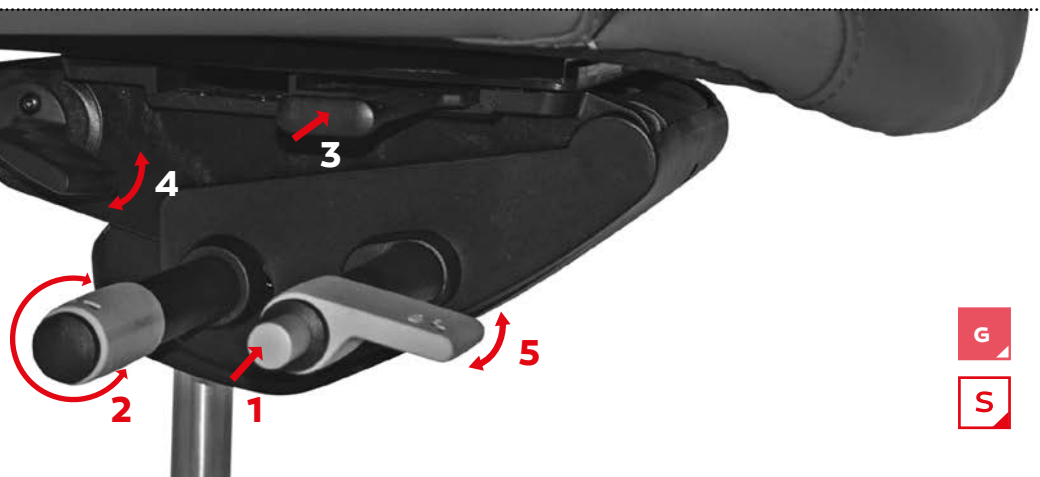

## KÓŁKA • ROLLEN • WHEELS



**DEM** - twarde kółko na miękkie podłoże, Ø 65 mm  
**DEMA** - twarde kółko na miękkie podłoże z hamulcem, Ø 65 mm

**DEM** - twarde kółko na miękkie podłoże, Ø 65 mm  
**DEMA** - twarde kółko na miękkie podłoże z hamulcem, Ø 65 mm

**DEM** - twarde kółko na miękkie podłoże, Ø 65 mm  
**DEMA** - twarde kółko na miękkie podłoże z hamulcem, Ø 65 mm



**DEMD** - miękkie kółko na twarde podłoże, Ø 65 mm  
**DEMDA** - miękkie kółko na twarde podłoże z hamulcem, Ø 65 mm

**DEMD** - miękkie kółko na twarde podłoże, Ø 65 mm  
**DEMDA** - miękkie kółko na twarde podłoże z hamulcem, Ø 65 mm

**DEMD** - miękkie kółko na twarde podłoże, Ø 65 mm  
**DEMDA** - miękkie kółko na twarde podłoże z hamulcem, Ø 65 mm



**ROL W** (białe)  
 -  
**ROL W** (weiß)  
 -  
**ROL W** (white)



**ROL C** (chrom)  
 -  
**ROL C** (chrom)OPTION: -  
 -  
**ROL C** (chrom)



**ROL G** (szary)  
 -  
**ROL G** (grau)  
 -  
**ROL G** (grey)

**O** optional elements / Optionsausstattung / wyposażenie opcjonalne

**S** standard elements / Standardausstattung / wyposażenie standardowe

## HAFT

**Możliwość wykonania haftu wg wzoru klienta.**

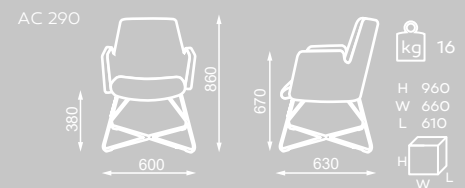
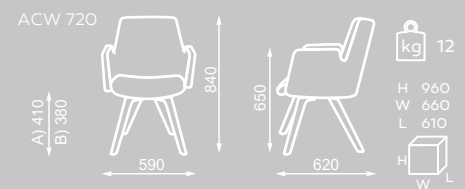
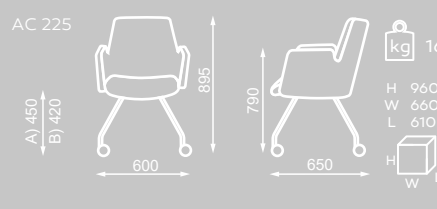
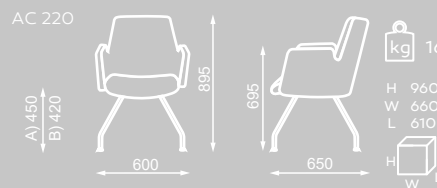
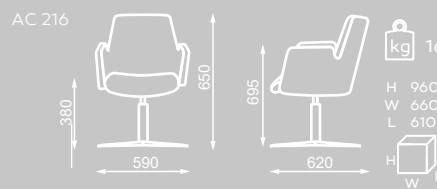
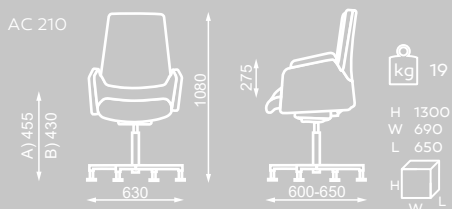
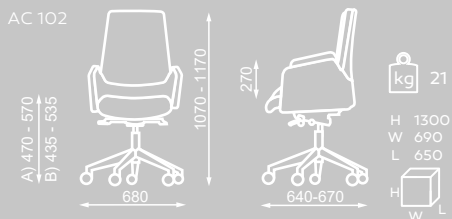
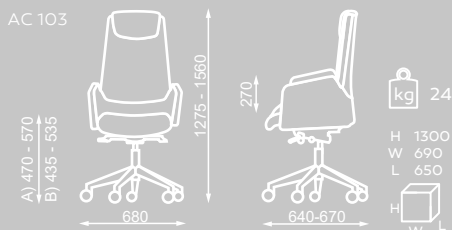

A) wysokość siedziska: wymiar gabarytowy  
 B) wysokość siedziska: pomiar zgodny z normą PN EN 1335-1

A) Sitzhöhe: Abmessung  
 B) Sitzhöhe: Messung kompatibel mit der Norm PN EN 1335-1

A) Seat height: overall dimensions  
 B) Seat height: measured according to the norm PN EN 1335-1

**5** lat gwarancji / Jahre Garantie / years guarantee

W opcjach wyposażenia różnych od przedstawionych wymiary foteli mogą się nieznacznie różnić. Przedstawiona kolorystyka nie stanowi oferty w rozumieniu prawa. Producent zastrzega sobie prawo do wprowadzania zmian konstrukcyjnych i zmian parametrów w oferowanych produktach nie zmieniając ich ogólnego charakteru.

In anderen Ausstattungsvarianten als hier vorgestellt können die Sesselabmessungen leicht variieren. Bei unterschiedlichen Konfigurationen der Produkte können die Maße leicht variieren. Der Hersteller behält sich das Recht vor, Änderungen an der Konstruktion sowie den Parametern an angebotenen Produkten vorzunehmen ohne ihren allgemeinen Charakter zu ändern.

In fitting options different from those presented armchair measurements can slightly differ. In the configuration of equipment different from the one seat dimensions may vary slightly. The manufacturer reserves the right to introduce changes in the design and parameters of products offered without changing their overall nature.



Bejot sp. z o.o., ul. Wybickiego 2A, Manieczki, 63-112 Brodnica n. Poznań, POLAND  
Tel.: + 48 (61) 281 22 25, fax: + 48 (61) 281 22 54, e-mail: [biuro@bejot.eu](mailto:biuro@bejot.eu)  
[www.bejot.eu](http://www.bejot.eu) | [www.zdrowesiedzenie.eu](http://www.zdrowesiedzenie.eu) | [www.gesundsitzen.com](http://www.gesundsitzen.com) | [www.healthysitting.eu](http://www.healthysitting.eu)

